

# T&D

Home Appliances

# T&D

Home Appliances

# 2024

GENERAL CATALOGUE

**elegance**  
**performance**  
**reliability**  
**respect for the environment.**  
this is the mission of T&D  
for you to Live the Quality.

Steel Gas Hobs 6

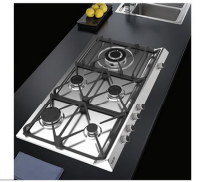

Glass Gas Hobs 20



Cooker Hoods 38



Built-In Ovens 55



Sinks And Water Taps 69



## Gas steel cooktops

Design, technology and high-grade materials are the ingredients of a cooking range characterised by high functionality, professional performance and energy saving. T&D cooker hobs are offered in a wide range of built-in versions; moreover, the cooker hob can be incorporated into the custom-sized stainless steel worktop. T&D cooker hobs are made of AISI 304 stainless steel and come in a variety of finishes.

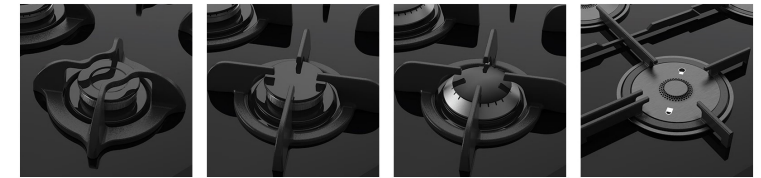
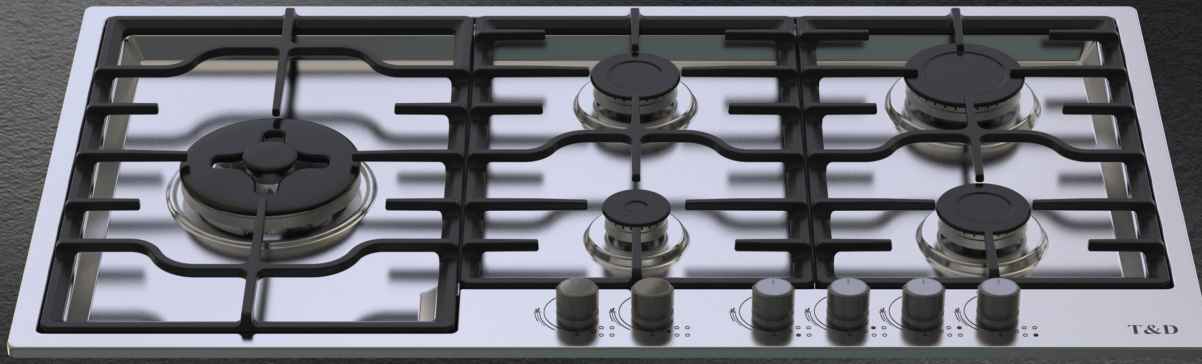

Type E

Sabaf S2

Sabaf S3

Series Flat



Dual wok



Triple ziglore E3

Type	Wok	Auxiliary	Rapid	Semi-Rapid
Type E	2.90 Kw	2.37 Kw	1.70 Kw	1.24 Kw
Sabaf S2	2.81 Kw	2.40 Kw	1.67 Kw	0.95 Kw
Sabaf S2	3.30 Kw	2.10 Kw	1.50 Kw	1.20 Kw
Flat	4.30 Kw	2.50 Kw	1.85 Kw	1.35 Kw
Dual Wok	4.80 Kw	-	-	-
Triple ziglore	3.50 Kw	-	-	-

## Safety in the kitchen

The ultra-rapid latest generation thermocouples make the burners even safer while the ignition time is reduced to the minimum.



### Flame Control

All T&D cooker hobs are equipped with safety valves. They shut off the gas supply very quickly if the flame accidentally goes out.



### Cast Iron Grids

All the T&D cooker hobs are equipped with cast-iron grids, a perfect material due to its many properties: high thermal capacity that improves the cooking efficiency; weight and stability that improve safety; sturdiness which keeps their look unaltered over time; easiness to clean.







### Simple Ignition

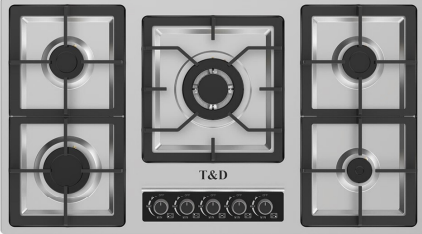

Integrated in to the knobs, electronic ignition provides easy and simple ignition for gas burner.

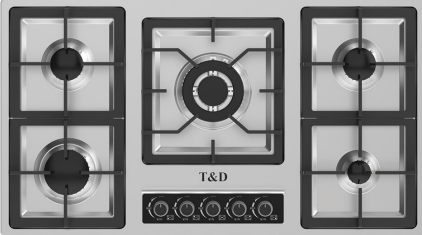

## Roma Series

	finish	code	burner
	brushed	103 E	Type B
			
Stainless steel dimensions: 900x510 mm cut-out: 830x470 mm Cast iron grids and enamelled burner covers Automatic electric ignition, Safety valves with ultra-rapid thermocouples Heat and electricity insulated knob			
			

	finish	code	burner
	brushed	103 S3	Series 3
			
Stainless steel dimensions: 900x510 mm cut-out: 830x470 mm Cast iron grids and enamelled burner covers Automatic electric ignition, Safety valves with ultra-rapid thermocouples Heat and electricity insulated knob Original series 3 Sabaf burner			
			

	finish	code	burner
	brushed	104 E	Type B
			
Stainless steel dimensions: 900x510 mm cut-out: 830x470 mm Cast iron grids and enamelled burner covers Automatic electric ignition, Safety valves with ultra-rapid thermocouples Heat and electricity insulated knob			
			

finish	code	burner
brushed	104 S3	Series 3



Stainless steel  
dimensions: 900x510 mm  
cut-out: 830x470 mm  
Cast iron grids and enamelled burner covers  
Automatic electric ignition, Safety valves with ultra-rapid thermocouples  
Heat and electricity insulated knob  
Original series 3 Sabaf burner



finish	code	burner
brushed	116 S2	Sabaf



Stainless steel  
dimensions: 900x510 mm  
cut-out: 830x470 mm  
Cast iron grids and enamelled burner covers  
Automatic electric ignition, Safety valves with ultra-rapid thermocouples  
Heat and electricity insulated knob  
Original Sabaf burner



finish	code	burner
brushed	112 E	Type B



Stainless steel  
dimensions: 900x510 mm  
cut-out: 830x470 mm  
Cast iron grids and enamelled burner covers  
Automatic electric ignition, Safety valves with ultra-rapid thermocouples  
Heat and electricity insulated knob



finish	code	burner
brushed	116 S3	Series 3



Stainless steel  
dimensions: 900x510 mm  
cut-out: 830x470 mm  
Cast iron grids and enamelled burner covers  
Automatic electric ignition, Safety valves with ultra-rapid thermocouples  
Heat and electricity insulated knob  
Original series 3 Sabaf burner



finish	code	burner
brushed	113 E	Type B







Stainless steel  
dimensions: 900x510 mm  
cut-out: 830x470 mm  
Cast iron grids and enamelled burner covers  
Automatic electric ignition, Safety valves with ultra-rapid thermocouples  
Heat and electricity insulated knob



finish	code	burner
brushed	117 S2	Sabaf







Stainless steel  
dimensions: 900x510 mm  
cut-out: 830x470 mm  
Cast iron grids and enamelled burner covers  
Automatic electric ignition, Safety valves with ultra-rapid thermocouples  
Heat and electricity insulated knob  
Original Sabaf burner

finish	code	burner
brushed	176 E	Type B







Stainless steel  
dimensions: 900x510 mm  
cut-out: 830x470 mm  
Cast iron grids and enamelled burner covers  
Automatic electric ignition, Safety valves with ultra-rapid thermocouples  
Heat and electricity insulated knob

finish	code	burner
brushed	117 S3	Sabaf







Stainless steel  
dimensions: 900x510 mm  
cut-out: 830x470 mm  
Cast iron grids and enamelled burner covers  
Automatic electric ignition, Safety valves with ultra-rapid thermocouples  
Heat and electricity insulated knob  
Original series 3 Sabaf burner

finish	code	burner
brushed	177 E	Type B





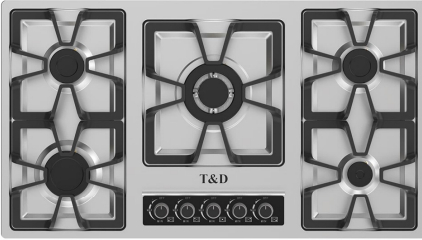

Stainless steel  
dimensions: 900x510 mm  
cut-out: 830x470 mm  
Cast iron grids and enamelled burner covers  
Automatic electric ignition, Safety valves with ultra-rapid thermocouples  
Heat and electricity insulated knob

finish	code	burner
brushed	178 S2	Sabaf



Stainless steel  
dimensions: 900x510 mm  
cut-out: 830x470 mm  
Cast iron grids and enamelled burner covers  
Automatic electric ignition, Safety valves with ultra-rapid thermocouples  
Heat and electricity insulated knob  
Original Sabaf burner

finish	code	burner
brushed	179 S2	Sabaf

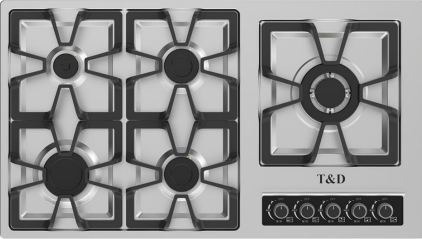

Stainless steel  
dimensions: 900x510 mm  
cut-out: 830x470 mm  
Cast iron grids and enamelled burner covers  
Automatic electric ignition, Safety valves with ultra-rapid thermocouples  
Heat and electricity insulated knob  
Original Sabaf burner



finish	code	burner
brushed	114 E	Type B



Stainless steel  
dimensions: 600x510 mm  
cut-out: 580x490 mm  
Cast iron grids and enamelled burner covers  
Automatic electric ignition, Safety valves with ultra-rapid thermocouples  
Heat and electricity insulated knob



finish	code	burner
brushed	181 S2	Sabaf

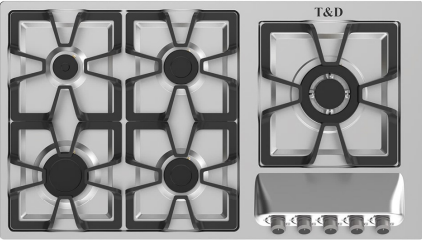

Stainless steel  
dimensions: 900x510 mm  
cut-out: 830x470 mm  
Cast iron grids and enamelled burner covers  
Automatic electric ignition, Safety valves with ultra-rapid thermocouples  
Heat and electricity insulated knob  
Original Sabaf burner



finish	code	burner
brushed	164 E	Type B



Stainless steel  
dimensions: 600x510 mm  
cut-out: 580x490 mm  
Cast iron grids and enamelled burner covers  
Automatic electric ignition, Safety valves with ultra-rapid thermocouples  
Heat and electricity insulated knob



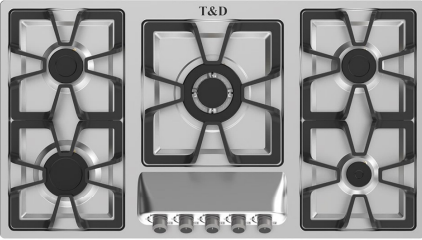

finish	code	burner
brushed	182 S2	Sabaf





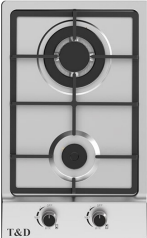

Stainless steel  
dimensions: 900x510 mm  
cut-out: 830x470 mm  
Cast iron grids and enamelled burner covers  
Automatic electric ignition, Safety valves with ultra-rapid thermocouples  
Heat and electricity insulated knob  
Original Sabaf burner



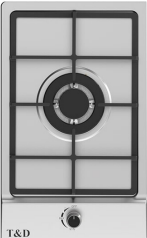



	finish	code	burner
	brushed	127 E	Type B
<p>Stainless steel            dimensions: 300x510 mm            cut-out: 270x480 mm            Cast iron grids and enamelled burner covers            Automatic electric ignition, Safety valves with ultra-rapid thermocouples            Heat and electricity insulated knob</p>			
			

	finish	code	Burner
	brushed	128 E	Type B
<p>Stainless steel            dimensions: 300x510 mm            cut-out: 270x480 mm            Cast iron grids and enamelled burner covers            Automatic electric ignition, Safety valves with ultra-rapid thermocouples            Heat and electricity insulated knob</p>			
			



	finish	code	burner
	brushed	148 E	Hot Plate
<p>AISI 304 stainless steel            dimensions: 300x510 mm            cut-out: 240x480 mm            Electrical hot plate            Heat and electricity insulated knob</p>			
			



	finish	code	burner
	brushed	147 E	Hot Plate
<p>AISI 304 stainless steel            dimensions: 300x510 mm            cut-out: 270x480 mm            Electrical hot plate            Heat and electricity insulated knob</p>			
			





## Lecce Series



	finish	code	burner
	brushed	136 E	Type B
			
<p>Stainless steel dimensions: 890x510 mm cut-out: 870x490 mm Cast iron grids and enamelled burner covers Automatic electric ignition, Safety valves with ultra-rapid thermocouples Heat and electricity insulated knob</p>			
			

	finish	code	burner
	brushed	150E	Type B
			
<p>Stainless steel dimensions: 890x510 mm cut-out: 870x490 mm Cast iron grids and enamelled burner covers Automatic electric ignition, Safety valves with ultra-rapid thermocouples Heat and electricity insulated knob</p>			
			

	finish	code	burner
	brushed	191 E	Type B
			
<p>Stainless steel dimensions: 890x510 mm cut-out: 870x500 mm Cast iron grids and enamelled burner covers Automatic electric ignition, Safety valves with ultra-rapid thermocouples Heat and electricity insulated knob</p>			
			



finish	code	burner
brushed	192 E	Type B

Stainless steel  
 dimensions: 890x510 mm  
 cut-out: 870x500 mm  
 Cast iron grids and enamelled burner covers  
 Automatic electric ignition, Safety valves with ultra-rapid thermocouples  
 Heat and electricity insulated knob



finish	code	Burner
brushed	198 E	Type B

Stainless steel  
 dimensions: 890x510 mm  
 cut-out: 870x500 mm  
 Cast iron grids and enamelled burner covers  
 Automatic electric ignition, Safety valves with ultra-rapid thermocouples  
 Heat and electricity insulated knob

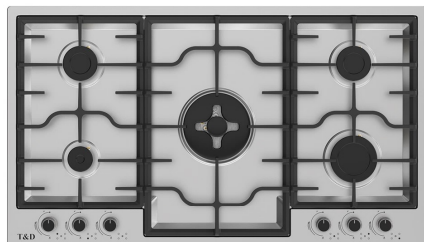

finish	code	burner
brushed	194 E	Type B-Dual Wok

Stainless steel  
 dimensions: 890x510 mm  
 cut-out: 870x500 mm  
 Cast iron grids and enamelled burner covers  
 Automatic electric ignition, Safety valves with ultra-rapid thermocouples  
 Heat and electricity insulated knob  
 Dual wok burner



finish	code	burner
brushed	195 E	Type B-Dual Wok

Stainless steel  
 dimensions: 890x510 mm  
 cut-out: 870x500 mm  
 Cast iron grids and enamelled burner covers  
 Automatic electric ignition, Safety valves with ultra-rapid thermocouples  
 Heat and electricity insulated knob  
 Dual wok burner

## Bolonia Series





### Tempered glass

Tempered or toughened glass is a type of safety glass processed by controlled thermal or chemical treatments to increase its strength compared with normal glass. Tempering puts the outer surfaces into compression and the interior into tension. Such stresses cause the glass, when broken, to shatter into small granular chunks instead of splintering into jagged shards as ordinary annealed glass does. The granular chunks are less likely to cause injury.

Tempered glass is used for its safety and strength in a variety of applications, including passenger vehicle windows, shower doors, aquariums, architectural glass doors and tables, refrigerator trays, mobile phone screen protectors, bulletproof glass components, diving masks, and plates and cookware.

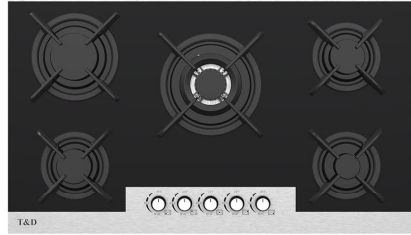

finish	code	burner
glass	102 E	Type B

Temperd Black Glass-Steel Frame  
 dimensions: **860x510 mm**  
 cut-out: 810x470 mm  
 Cast iron grids and enamelled burner covers  
 Automatic electric ignition, Safety valves with ultra-rapid thermocouples  
 Heat and electricity insulated knob



finish	code	burner
glass	105 E	Type B

Temperd Black Glass  
 dimensions: **900x520 mm**  
 cut-out: 830x480 mm  
 Cast iron grids and enamelled burner covers  
 Automatic electric ignition, Safety valves with ultra-rapid thermocouples  
 Heat and electricity insulated knob

finish	code	burner
glass	105 S2	Sabaf

Temperd Black Glass  
 dimensions: **900x520 mm**  
 cut-out: 830x470 mm  
 Cast iron grids and enamelled burner covers  
 Automatic electric ignition, Safety valves with ultra-rapid thermocouples  
 Heat and electricity insulated knob  
 Original Sabaf burner



finish	code	burner
glass	106 E	Type B

Temperd Black Glass  
 dimensions: 900x520 mm  
 cut-out: 830x470 mm  
 Cast iron grids and enamelled burner covers  
 Automatic electric ignition, Safety valves with  
 ultra-rapid thermocouples  
 Heat and electricity insulated knob

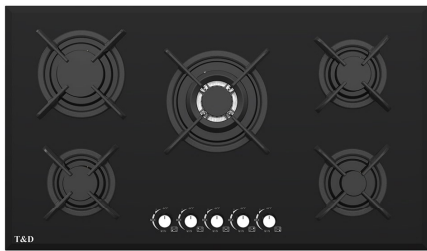

finish	code	burner
glass	106 S2	Sabaf

Temperd Black Glass  
 dimensions: 900x520 mm  
 cut-out: 830x470 mm  
 Cast iron grids and enamelled burner covers  
 Automatic electric ignition, Safety valves with  
 ultra-rapid thermocouples  
 Heat and electricity insulated knob  
 Original Sabaf burner



finish	code	burner
glass	145 S2	Sabaf

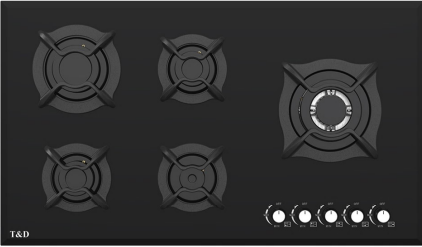

Temperd Black Glass  
dimensions: 900x520 mm  
cut-out: 830x470 mm  
Cast iron grids and enamelled burner covers  
Automatic electric ignition, Safety valves with ultra-rapid thermocouples  
Heat and electricity insulated knob  
Original Sabaf burner



finish	code	burner
glass	155 S2	Sabaf

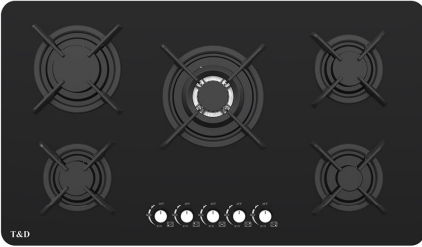

Temperd Black Glass  
dimensions: 900x520 mm  
cut-out: 830x470 mm  
Cast iron grids and enamelled burner covers  
Automatic electric ignition, Safety valves with ultra-rapid thermocouples  
Heat and electricity insulated knob  
Original Sabaf burner



finish	code	burner
glass	146 S2	Sabaf

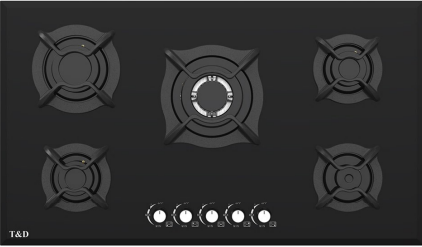

Temperd Black Glass  
dimensions: 900x520 mm  
cut-out: 830x470 mm  
Cast iron grids and enamelled burner covers  
Automatic electric ignition, Safety valves with ultra-rapid thermocouples  
Heat and electricity insulated knob  
Original Sabaf burner



finish	code	burner
glass	156 S2	Sabaf

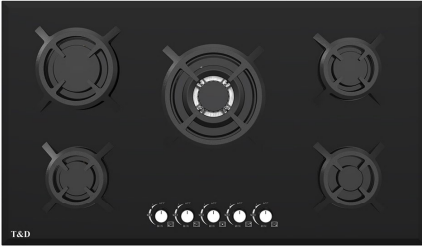

Temperd Black Glass  
dimensions: 900x520 mm  
cut-out: 830x470 mm  
Cast iron grids and enamelled burner covers  
Automatic electric ignition, Safety valves with ultra-rapid thermocouples  
Heat and electricity insulated knob  
Original Sabaf burner



finish	code	burner
glass	157 S2	Sabaf



Temperd Black Glass  
dimensions: 900x520 mm  
cut-out: 830x470 mm  
Cast iron grids and enamelled burner covers  
Automatic electric ignition, Safety valves with ultra-rapid thermocouples  
Heat and electricity insulated knob  
Original Sabaf burner



finish	code	burner
glass	160 E	Type B



Temperd Black Glass  
dimensions: 900x520 mm  
cut-out: 830x470 mm  
Cast iron grids and enamelled burner covers  
Automatic electric ignition, Safety valves with ultra-rapid thermocouples  
Heat and electricity insulated knob





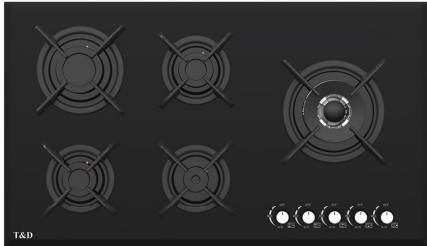

finish	code	burner
glass	169 E3	Type B-Triple Ziglore Wok







Temperd Black Glass  
dimensions: 900x520 mm  
cut-out: 830x470 mm  
Cast iron grids and enamelled burner covers  
Automatic electric ignition, Safety valves with ultra-rapid thermocouples  
Heat and electricity insulated knob  
Triple ziglor wok burner

finish	code	burner
glass	167 S3	Series 3





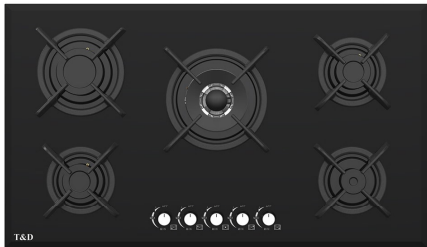

Temperd Black Glass  
dimensions: 900x520 mm  
cut-out: 830x470 mm  
Cast iron grids and enamelled burner covers  
Automatic electric ignition, Safety valves with ultra-rapid thermocouples  
Heat and electricity insulated knob  
Original series 3 Sabaf burner

finish	code	burner
glass	170 E3	Type B-Triple Ziglore Wok





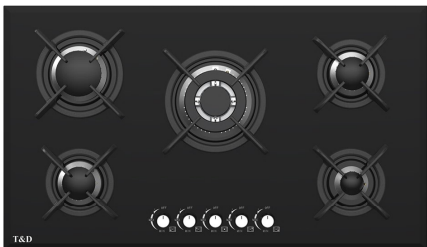

Temperd Black Glass  
dimensions: 900x520 mm  
cut-out: 830x470 mm  
Cast iron grids and enamelled burner covers  
Automatic electric ignition, Safety valves with ultra-rapid thermocouples  
Heat and electricity insulated knob  
Triple ziglor wok burner

finish	code	burner
glass	168 S3	Series 3





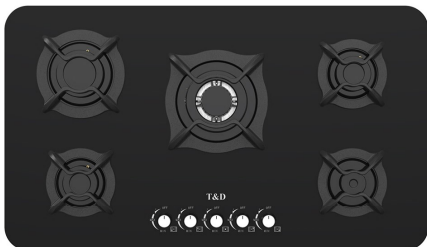

Temperd Black Glass  
dimensions: 900x520 mm  
cut-out: 830x470 mm  
Cast iron grids and enamelled burner covers  
Automatic electric ignition, Safety valves with ultra-rapid thermocouples  
Heat and electricity insulated knob  
Original series 3 Sabaf burner

finish	code	burner
glass	180 E	Type B



Temperd Black Glass  
dimensions: 900x520 mm  
cut-out: 830x470 mm  
Cast iron grids and enamelled burner covers  
Automatic electric ignition, Safety valves with ultra-rapid thermocouples  
Heat and electricity insulated knob

finish	code	burner
glass	196 E	Type B

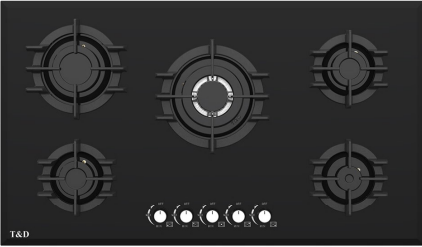

Temperd Black Glass  
dimensions: 900x520 mm  
cut-out: 830x470 mm  
Cast iron grids and enamelled burner covers  
Automatic electric ignition, Safety valves with ultra-rapid thermocouples  
Heat and electricity insulated knob



finish	code	burner
glass	163 E	Type B

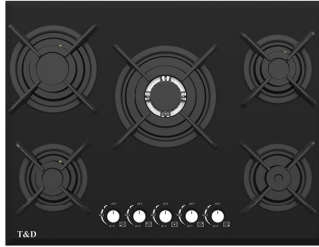

Temperd Black Glass  
dimensions: 700x520 mm  
cut-out: 650x490 mm  
Cast iron grids and enamelled burner covers  
Automatic electric ignition, Safety valves with ultra-rapid thermocouples  
Heat and electricity insulated knob



finish	code	burner
glass	197 E	Type B

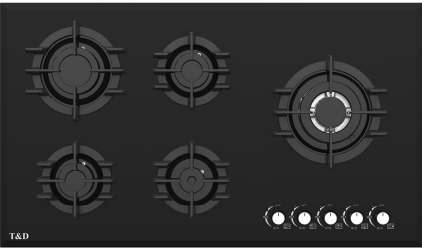

Temperd Black Glass  
dimensions: 900x520 mm  
cut-out: 830x470 mm  
Cast iron grids and enamelled burner covers  
Automatic electric ignition, Safety valves with ultra-rapid thermocouples  
Heat and electricity insulated knob



finish	code	burner
glass	115 E	Type B

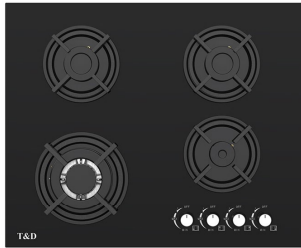

Temperd Black Glass  
dimensions: 600x520 mm  
cut-out: 530x470 mm  
Cast iron grids and enamelled burner covers  
Automatic electric ignition, Safety valves with ultra-rapid thermocouples  
Heat and electricity insulated knob



finish	code	burner
glass	152 S2	Sabaf

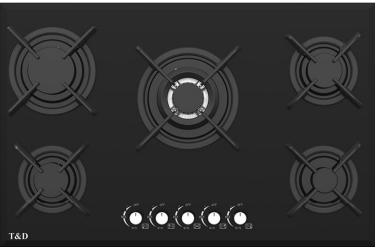

Temperd Black Glass  
dimensions: 800x520 mm  
cut-out: 670x480 mm  
Cast iron grids and enamelled burner covers  
Automatic electric ignition, Safety valves with ultra-rapid thermocouples  
Heat and electricity insulated knob  
Original Sabaf burner



finish	code	burner
glass	115 i	Sabaf

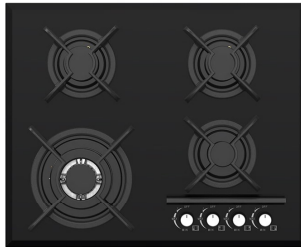

Temperd Black Schott Glass  
dimensions: 600x520 mm  
cut-out: 530x470 mm  
Cast iron grids and enamelled burner covers  
Automatic electric ignition, Safety valves with ultra-rapid thermocouples  
Heat and electricity insulated knob  
Original Sabaf burner



finish	code	burner
glass	153 E	Type B

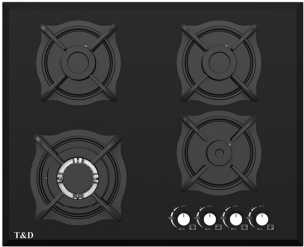

Temperd Black Glass  
dimensions: 600x520 mm  
cut-out: 530x470 mm  
Cast iron grids and enamelled burner covers  
Automatic electric ignition, Safety valves with ultra-rapid thermocouples  
Heat and electricity insulated knob



finish	code	burner
glass	183 E	Type B



Temperd Black Glass  
dimensions: 600x520 mm  
cut-out: 530x470 mm  
Cast iron grids and enamelled burner covers  
Automatic electric ignition, Safety valves with ultra-rapid thermocouples  
Heat and electricity insulated knob



finish	code	burner
glass	175 E	Type B

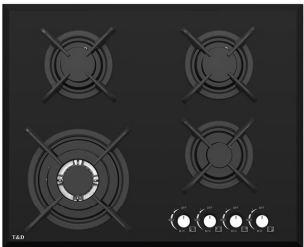

Temperd Black Glass  
dimensions: 600x520 mm  
cut-out: 530x470 mm  
Cast iron grids and enamelled burner covers  
Automatic electric ignition, Safety valves with ultra-rapid thermocouples  
Heat and electricity insulated knob



finish	code	burner
glass	129 E	Type B

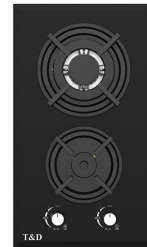

Temperd Black Glass  
dimensions: 320x520 mm  
cut-out: 270x480 mm  
Cast iron grids and enamelled burner covers  
Automatic electric ignition, Safety valves with ultra-rapid thermocouples  
Heat and electricity insulated knob



finish	code	burner
glass	149 E	Type B

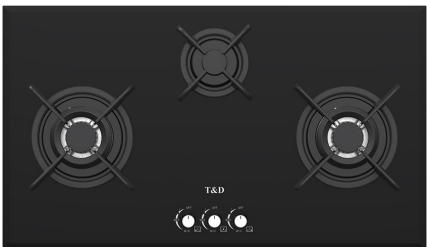

Temperd Black Glass  
dimensions: 900x520 mm  
cut-out: 830x470 mm  
Cast iron grids and enamelled burner covers  
Automatic electric ignition, Safety valves with ultra-rapid thermocouples  
Heat and electricity insulated knob



finish	code	Burner
Glass	126E	Type B

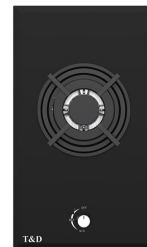

Temperd Black Glass  
dimensions: 320x520 mm  
cut-out: 270x480 mm  
Cast iron grids and enamelled burner covers  
Automatic electric ignition, Safety valves with ultra-rapid thermocouples  
Heat and electricity insulated knob





# Bianco Series

finish	code	burner
glass	132 i	Sabaf

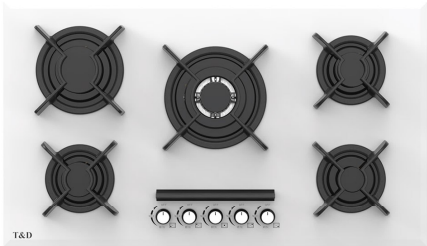

Temperd White Schott Glass  
dimensions: 900x520 mm  
cut-out: 830x470 mm  
Cast iron grids and enamelled burner covers  
Automatic electric ignition, Safety valves with ultra-rapid thermocouples  
Heat and electricity insulated knob  
Original Sabaf burner



finish	code	burner
glass	133 S2	Sabaf



Temperd White Schott Glass  
dimensions: 900x520 mm  
cut-out: 830x470 mm  
Cast iron grids and enamelled burner covers  
Automatic electric ignition, Safety valves with ultra-rapid thermocouples  
Heat and electricity insulated knob  
Original Sabaf burner



finish	code	burner
glass	132 S2	Sabaf

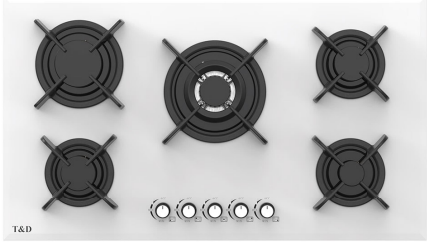

Temperd White Schott Glass  
dimensions: 900x520 mm  
cut-out: 830x470 mm  
Cast iron grids and enamelled burner covers  
Automatic electric ignition, Safety valves with ultra-rapid thermocouples  
Heat and electricity insulated knob  
Original Sabaf burner



finish	code	burner
glass	161 S2	Type B



Temperd White Schott Glass  
dimensions: 900x520 mm  
cut-out: 830x470 mm  
Cast iron grids and enamelled burner covers  
Automatic electric ignition, Safety valves with ultra-rapid thermocouples  
Heat and electricity insulated knob  
Original Sabaf burner



finish	code	burner
glass	133 i	Sabaf

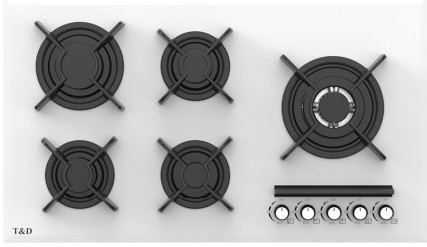

Temperd White Schott Glass  
dimensions: 900x520 mm  
cut-out: 830x470 mm  
Cast iron grids and enamelled burner covers  
Automatic electric ignition, Safety valves with ultra-rapid thermocouples  
Heat and electricity insulated knob  
Original Sabaf burner



finish	code	burner
glass	162 S2	Type B

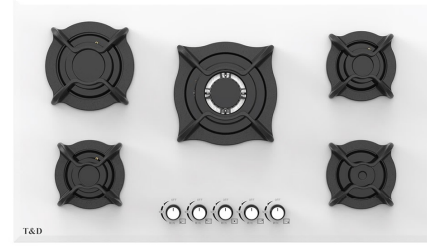

Temperd White Schott Glass  
dimensions: 900x520 mm  
cut-out: 830x470 mm  
Cast iron grids and enamelled burner covers  
Automatic electric ignition, Safety valves with ultra-rapid thermocouples  
Heat and electricity insulated knob  
Original Sabaf burner





## Flat Series

finish	code	burner
glass	171 EF	Flat

Temperd Black Glass  
dimensions: 900x520 mm  
cut-out: 830x470 mm  
Cast iron grids and enamelled burner covers  
Automatic electric ignition, Safety valves with ultra-rapid thermocouples  
Heat and electricity insulated knob  
Flat burner

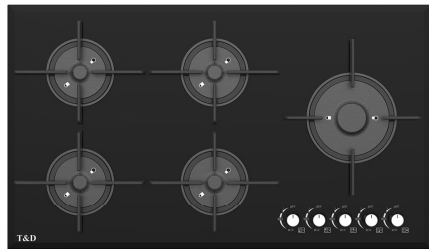

finish	code	burner
glass	174 EF	Flat

Temperd Black Glass  
dimensions: 900x520 mm  
cut-out: 830x470 mm  
Cast iron grids and enamelled burner covers  
Automatic electric ignition, Safety valves with ultra-rapid thermocouples  
Heat and electricity insulated knob  
Flat burner

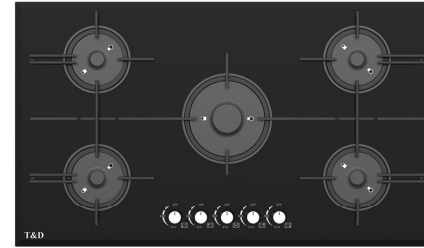

finish	code	burner
glass	184 EF	Flat

Temperd Black Glass  
dimensions: 900x520 mm  
cut-out: 830x470 mm  
Cast iron grids and enamelled burner covers  
Automatic electric ignition, Safety valves with ultra-rapid thermocouples  
Heat and electricity insulated knob  
Flat burner

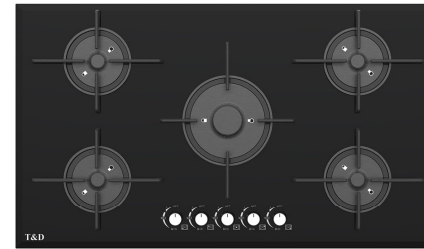

finish	code	burner
glass	188 EF	Flat

Temperd Black Glass  
dimensions: 900x520 mm  
cut-out: 830x470 mm  
Cast iron grids and enamelled burner covers  
Automatic electric ignition, Safety valves with ultra-rapid thermocouples  
Heat and electricity insulated knob  
Flat burner

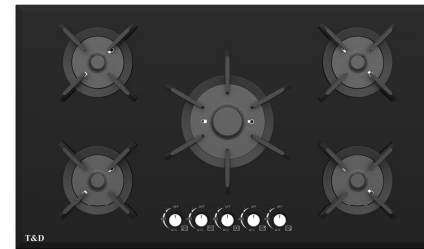

## Kitchen hood

Silent, efficient, modern and constructed using satin finish stainless steel, the same material comprising the cooker hobs and sinks. A T&D coordinated appliance enables you to express your style in every detail.

## Blower

Power and quietness are the two principal features of a cooker hood, even though they are often in contrast with one-another. The continuous strive for the best compromise is however nowadays able to achieve surprising results. All the T&D solutions have an outstanding suction power which makes them efficient and well-performing in all conditions of use, both in extracting and filtering modes. All this is achieved quietly, thanks to motors and aerodynamic solutions carefully studied to reduce the acoustic impact to a minimum.

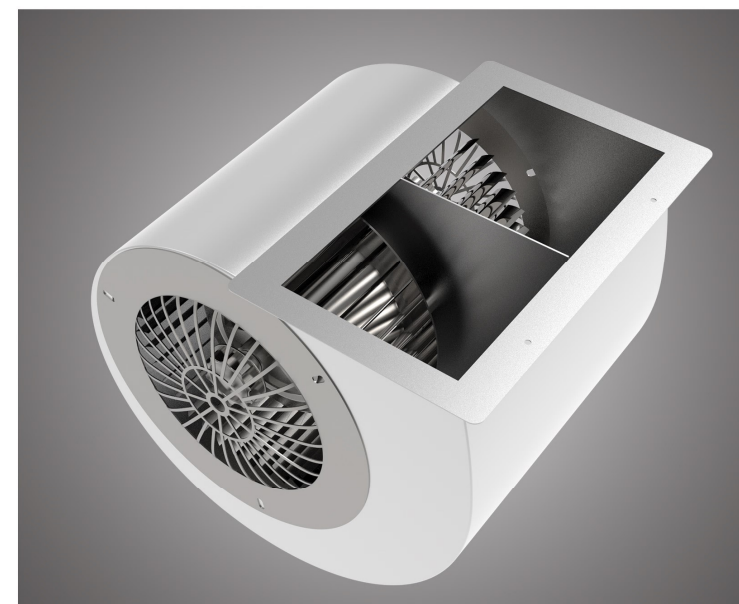

Turbo metal blower



Metal propellers



PP propellers

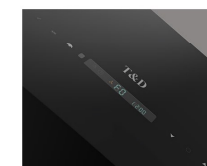

Switch panel

## A hood for every kitchen

A really complete range, with every kind of hood. Non only different looks, but also different functioning principles, in order to be able to choose the hood which fits each one's needs.



### Remote control

T&D hoods are equipped with a remote control.



### LED lighting

All of T&D hoods feature a LED lighting system.



### Metalic blower

T&D blower allow high air flow rates while maintaining a low energy consumption.



### Auto system

With the Auto function the hood has smoke sensors.





### Automatic door

Electrical automatic door



## Chimney Series

	finish	code	blower
	glass	03 E	turbo
<p>Tempered Black Glass dimentions: <b>900 mm</b> Turbo 4 speeds blower Aluminium filters, 3 ply and washable Halogen lighting 2x2 W Air flow rate: 700 m3/h Motor power: 250 W</p>			

	finish	code	blower
	glass	03 S	turbo metal
<p>Tempered Black Glass dimentions: <b>900 mm</b> Turbo 5 speeds metal blower Aluminium filters, 3 ply and washable LED lighting 2x2 W Smoke sensor Air flow rate: 700 m3/h Motor power: 250 W</p>			





	finish	code	blower
	glass	07 S	turbo metal
<p>Tempered Black Glass dimentions: <b>900 mm</b> Turbo 5 speeds metal blower Aluminium filters, 3 ply and washable Halogen lighting 2x2 W Smoke sensor Air flow rate: 700 m3/h Motor power: 250 W</p>			

## Wall-mounted Series





	finish	code	blower
	glass	08 S	turbo metal
<p>Tempered Black Glass            dimensions: <b>900 mm</b>            Turbo 5 speeds metal blower            Aluminium filters, 3 ply and washable            LED lighting 2x2 W            Smoke sensor            Air flow rate: 700 m3/h            Motor power: 250 W</p>			

   



	finish	code	blower
	glass	09 E	turbo
<p>Tempered Black Glass            dimensions: <b>900 mm</b>            Turbo 4 speeds blower            Aluminium filters, 3 ply and washable            LED lighting 2x2 W            Automatic door            Air flow rate: 700 m3/h            Motor power: 250 W</p>			

   





	finish	code	blower
	glass	12 S	turbo metal
<p>Tempered Black Glass            dimensions: <b>900 mm</b>            Turbo 5 speeds metal blower            Aluminium filters, 3 ply and washable            LED lighting 2x2 W            Smoke sensor            Air flow rate: 700 m3/h            Motor power: 250 W</p>			

   



	finish	code	blower
	glass	14 E	turbo
<p>Tempered Black Glass            dimensions: <b>900 mm</b>            Turbo 4 speeds blower            Aluminium filters, 3 ply and washable            LED lighting 2x2 W            Smoke sensor            Air flow rate: 700 m3/h            Motor power: 250 W</p>			

	finish	code	blower
	glass	04 S	turbo metal
<p>Tempered Black Glass            dimensions: <b>600 mm</b>            Turbo 5 speeds metal blower            Aluminium filters, 3 ply and washable            LED lighting 2x2 W            Smoke sensor            Air flow rate: 700 m3/h            Motor power: 250 W</p>			

   

	finish	code	blower
	glass	16 E	turbo
<p>Tempered Black Glass            dimensions: <b>900 mm</b>            Turbo 4 speeds blower            Aluminium filters, 3 ply and washable            LED lighting 2x2 W            Smoke sensor            Air flow rate: 700 m3/h            Motor power: 250 W</p>			



finish	code	blower
glass	18 S	turbo metal

Tempered Black Glass  
 dimensions: 900 mm  
 Turbo 5 speeds metal blower  
 Aluminium filters, 3 ply and washable  
 LED lighting 2x2 W  
 Automatic door  
 Air flow rate: 700 m3/h  
 Motor power: 250 W



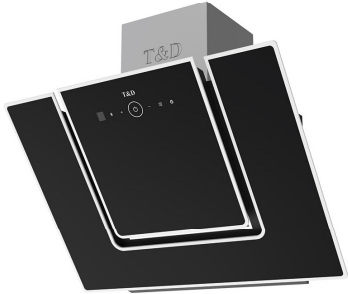

finish	code	blower
glass	19 S	turbo metal

Tempered Black Glass  
 dimensions: 900 mm  
 Turbo 5 speeds metal blower  
 Aluminium filters, 3 ply and washable  
 LED lighting 2x2 W  
 Automatic door  
 Air flow rate: 700 m3/h  
 Motor power: 250 W







finish	code	blower
glass	25 S	turbo metal

Tempered Black Glass  
 dimensions: 900 mm  
 Turbo 5 speeds metal blower  
 Aluminium filters, 3 ply and washable  
 LED lighting 2x2 W  
 Smoke sensor  
 Air flow rate: 700 m3/h  
 Motor power: 250 W

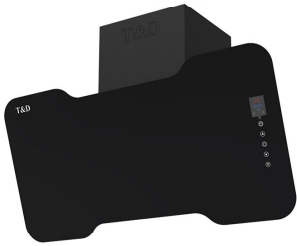





	finish	code	blower
	glass	27 S	turbo metal
<p>Tempered White Glass            dimensions: 900 mm            Turbo 5 speeds metal blower            Aluminium filters, 3 ply and washable            LED lighting 2x2 W            Smoke sensor            Air flow rate: 700 m3/h            Motor power: 250 W</p>			
			

	finish	code	blower
	glass	36 E	turbo
<p>Tempered Black Glass            dimensions: 900 mm            Turbo 4 speeds blower            Aluminium filters, 3 ply and washable            LED lighting 2x2 W            Air flow rate: 700 m3/h            Motor power: 250 W</p>			
			



	finish	code	blower
	glass	31 E	turbo
<p>Tempered Black Glass            dimensions: 900 mm            Turbo 4 speeds blower            Aluminium filters, 3 ply and washable            LED lighting 2x2 W            Smoke sensor            Air flow rate: 700 m3/h            Motor power: 250 W</p>			
			



	finish	code	blower
	glass	41 E	turbo
<p>Tempered Black Glass            dimensions: 900 mm            Turbo 4 speeds blower            Aluminium filters, 3 ply and washable            LED lighting 2x2 W            Air flow rate: 700 m3/h            Motor power: 250 W</p>			
			

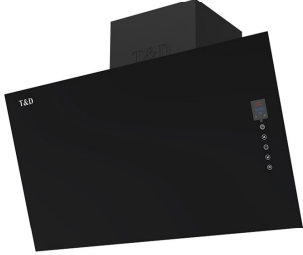

	finish	code	blower
	glass	32 E	turbo
<p>Tempered Black Glass            dimensions: 900 mm            Turbo 4 speeds blower            Aluminium filters, 3 ply and washable            LED lighting 2x2 W            Air flow rate: 700 m3/h            Motor power: 250 W</p>			
			



	finish	code	blower
	glass	45 E	turbo
<p>Tempered Black Glass            dimensions: 900 mm            Turbo 4 speeds blower            Aluminium filters, 3 ply and washable            LED lighting 2x2 W            Air flow rate: 700 m3/h            Motor power: 250 W</p>			
			



	finish	code	blower
	glass	48 E	turbo
<p>Tempered Black Glass            dimensions: <b>900 mm</b>            Turbo 4 speeds blower            Aluminium filters, 3 ply and washable            LED lighting 2x2 W            Air flow rate: 700 m3/h            Motor power: 250 W</p>			
 			

	finish	code	blower
	glass	52 E	turbo
<p>Tempered Black Glass            dimensions: <b>900 mm</b>            Turbo 4 speeds blower            Aluminium filters, 3 ply and washable            LED lighting 2x2 W            Air flow rate: 700 m3/h            Motor power: 250 W</p>			
 			

	finish	code	blower
	glass	50 E	turbo
<p>Tempered Black Glass            dimensions: <b>900 mm</b>            Turbo 4 speeds blower            Push button            Aluminium filters, 3 ply and washable            LED lighting 3 W            Air flow rate: 700 m3/h            Motor power: 250 W</p>			
			

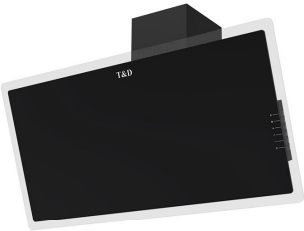

	finish	code	blower
	glass	56 E	turbo
<p>Tempered Black Glass            dimensions: <b>900 mm</b>            Turbo 4 speeds blower            Aluminium filters, 3 ply and washable            LED lighting 2x2 W            Air flow rate: 700 m3/h            Motor power: 250 W</p>			
 			

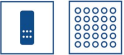

	finish	code	blower
	glass	51 E	turbo
<p>Tempered Black Glass            dimensions: <b>900 mm</b>            Turbo 4 speeds blower            Aluminium filters, 3 ply and washable            LED lighting 2x2 W            Air flow rate: 700 m3/h            Motor power: 250 W</p>			
 			

	finish	code	blower
	glass	58 E	turbo
<p>Tempered Black Glass            dimensions: <b>900 mm</b>            Turbo 4 speeds blower            Push button            Aluminium filters, 3 ply and washable            LED lighting 2x2 W            Air flow rate: 700 m3/h            Motor power: 250 W</p>			
			





	finish	code	blower
	glass	20 E	turbo
<p>Tempered Black Glass            dimensions: <b>800 mm</b>            Turbo 4 speeds blower            Aluminium filters, 3 ply and washable            LED lighting 2x2 W            Air flow rate: 700 m3/h            Motor power: 250 W</p>			
			

	finish	code	blower
	glass	29 S	turbo metal
<p>Tempered Black Glass            dimensions: <b>600 mm</b>            Turbo 5 speeds metal blower            Aluminium filters, 3 ply and washable            LED lighting 2x2 W            Smoke sensor            Air flow rate: 700 m3/h            Motor power: 250 W</p>			
			

	finish	code	blower
	glass	40 E	turbo
<p>Tempered Black Glass            dimensions: <b>800 mm</b>            Turbo 4 speeds blower            Aluminium filters, 3 ply and washable            LED lighting 2x2 W            Air flow rate: 700 m3/h            Motor power: 250 W</p>			
			

	finish	code	blower
	glass	39 E	turbo
<p>Tempered Black Glass            dimensions: <b>600 mm</b>            Turbo 4 speeds blower            Aluminium filters, 3 ply and washable            LED lighting 2x2 W            Air flow rate: 700 m3/h            Motor power: 250 W</p>			
			

	finish	code	blower
	glass	29 E	turbo
<p>Tempered Black Glass            dimensions: <b>600 mm</b>            Turbo 4 speeds blower            Aluminium filters, 3 ply and washable            LED lighting 2x2 W            Air flow rate: 700 m3/h            Motor power: 250 W</p>			
			



## Hidden Series

finish	code	blower
glass	42 E	turbo



Tempered Black Glass  
 dimensions: 800 mm  
 cut-out: 780x270 mm  
 Turbo 4 speeds blower  
 Aluminium filters, 3 ply and washable  
 LED lighting 2x2 W  
 Air flow rate: 700 m3/h  
 Motor power: 250 W



finish	code	blower
glass	46 E	turbo

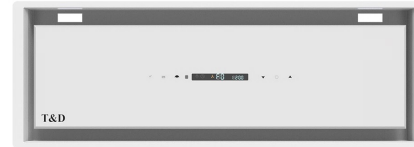

Tempered White Glass  
 dimensions: 800 mm  
 cut-out: 780x270 mm  
 Turbo 4 speeds blower  
 Aluminium filters, 3 ply and washable  
 LED lighting 2x2 W  
 Air flow rate: 700 m3/h  
 Motor power: 250 W



finish	code	blower
glass	64 S	turbo metal



Tempered Black Glass  
 dimensions: 700 mm  
 cut-out: 675x275 mm  
 Turbo 4 speeds metal blower  
 Aluminium filters, 3 ply and washable  
 LED lighting 3 W  
 Air flow rate: 700 m3/h  
 Motor power: 250 W



finish	code	blower
glass	62 E	turbo



Tempered Black Glass  
 dimensions: 700 mm  
 cut-out: 685x265 mm  
 Turbo 4 speeds blower  
 Aluminium filters, 3 ply and washable  
 LED lighting 3 W  
 Smoke sensor  
 Air flow rate: 700 m3/h  
 Motor power: 250 W



finish	code	blower
glass	65 S	turbo metal

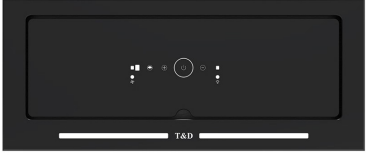

Tempered Black Glass  
 dimensions: **700 mm**  
 cut-out: 675x275 mm  
 Turbo 4 speeds metal blower  
 Aluminium filters, 3 ply and washable  
 LED lighting 3 W  
 Touchless switch and smoke sensor  
 Air flow rate: 700 m3/h  
 Motor power: 250 W



finish	code	blower
glass	60 E	turbo



Tempered Black Glass  
 dimensions: **700 mm**  
 cut-out: 675x275 mm  
 Turbo 4 speeds blower  
 Aluminium filters, 3 ply and washable  
 LED lighting 2x2 W  
 Air flow rate: 700 m3/h  
 Motor power: 250 W



finish	code	blower
steel	35 E	turbo

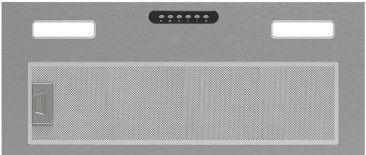

Stainless Steel Frame  
 dimensions: **700 mm**  
 cut-out: 665x275 mm  
 Turbo 4 speeds blower  
 Push button  
 Aluminium filters, 3 ply and washable  
 LED lighting 2x3 W  
 Air flow rate: 700 m3/h  
 Motor power: 250 W



finish	code	blower
colored	55 E	turbo



Black Frame  
 dimensions: **700 mm**  
 cut-out: 665x275 mm  
 Turbo 4 speeds blower  
 Push button  
 Aluminium filters, 3 ply and washable  
 LED lighting 2x3 W  
 Air flow rate: 700 m3/h  
 Motor power: 250 W



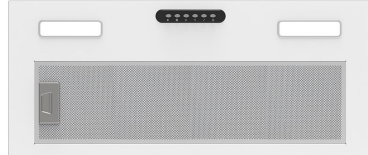

finish	code	blower
colored	59 E	turbo



White Frame  
 dimensions: **700 mm**  
 cut-out: 665x275 mm  
 Turbo 4 speeds blower  
 Push button  
 Aluminium filters, 3 ply and washable  
 LED lighting 2x3 W  
 Air flow rate: 700 m3/h  
 Motor power: 250 W



finish	code	blower
colored	61 E	turbo

Black Frame  
 dimensions: **700 mm**  
 cut-out: 665x275 mm  
 Turbo 4 speeds metal blower  
 Aluminium filters, 3 ply and washable  
 LED lighting 2x3 W  
 Air flow rate: 700 m3/h  
 Motor power: 250 W



## Built-in ovens

With a cooking chamber capacity of 60-78 litres and 5 different cooking levels, T&D ovens top their category for guaranteed capacity featured on a 60x60 cm built-in oven. XL means that those models feature a capacity exceeding 60 litres.

In many models the inside of the oven door constitutes a single smooth glass surface making it practical for cleaning purposes.

The Easy-Clean enamelling makes the internal oven surfaces and accessories non-adhesive, while the limited porosity ensures durability and easy cleaning.



Steel shelves

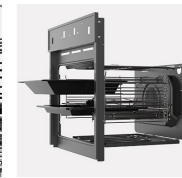

Telescopic guides



Series 3



Soft closing door



Touch panel



Knob control



Convection fan



Fast preheating



Cooling system



Telescopic guides



Meat probe



Cooking programs



Electric/Gas oven



3 ply glass



Usable capacity



Rotary roast



Defrost system



Easy clean











Heat element











Child lock system

# Built-in Series









	finish	code	cooking method
	glass	201	electric-gas
<ul style="list-style-type: none"> <li>• Multifunctional oven 60x60 cm, 63 litres capacity</li> <li>• Timer display</li> <li>• Manually cooking with programmed recipes</li> <li>• Cooling system with tangential ventilation</li> <li>• 3 ply tempered glass door</li> <li>• Full-Glass door</li> <li>• Removable inner glass</li> <li>• Easy-Clean enamelling</li> <li>• Rotary roast</li> <li>• Safety shut-off system</li> <li>• Aluminium door handle</li> <li>• 5 shelf position</li> <li>• Energy class: A</li> <li>• Power supply: 220-240 V 50-60 Hz</li> </ul>			



















	finish	code	cooking method
	glass	206	electric-gas
<ul style="list-style-type: none"> <li>• Multifunctional oven 60x60 cm, 63 litres capacity</li> <li>• Timer display</li> <li>• Manually cooking with programmed recipes</li> <li>• Cooling system with tangential ventilation</li> <li>• 3 ply tempered glass door</li> <li>• Full-Glass door</li> <li>• Removable inner glass</li> <li>• Easy-Clean enamelling</li> <li>• Rotary roast</li> <li>• Safety shut-off system</li> <li>• Aluminium door handle</li> <li>• 5 shelf position</li> <li>• Energy class: A</li> <li>• Power supply: 220-240 V 50-60 Hz</li> </ul>			













	finish	code	cooking method
	glass	205	electric-gas
<ul style="list-style-type: none"> <li>• Multifunctional oven 60x60 cm, 63 litres capacity</li> <li>• Timer display</li> <li>• Manually cooking with programmed recipes</li> <li>• Cooling system with tangential ventilation</li> <li>• 3 ply tempered glass door</li> <li>• Full-Glass door</li> <li>• Removable inner glass</li> <li>• Easy-Clean enamelling</li> <li>• Rotary roast</li> <li>• Safety shut-off system</li> <li>• Aluminium door handle</li> <li>• 5 shelf position</li> <li>• Energy class: A</li> <li>• Power supply: 220-240 V 50-60 Hz</li> </ul>			













	finish	code	cooking method
	glass	209	10
<ul style="list-style-type: none"> <li>• Multifunctional oven 60x60 cm, 63 litres capacity</li> <li>• Timer display</li> <li>• Manually cooking with programmed recipes</li> <li>• Cooling system with tangential ventilation</li> <li>• 3 ply tempered glass door</li> <li>• Full-Glass door</li> <li>• Removable inner glass</li> <li>• Easy-Clean enamelling</li> <li>• Rotary roast</li> <li>• Safety shut-off system</li> <li>• Aluminium door handle</li> <li>• 5 shelf position</li> <li>• Energy class: A</li> <li>• Power supply: 220-240 V 50-60 Hz</li> </ul>			

















	finish	code	cooking method
	glass	212	13
	<ul style="list-style-type: none"> <li>• Multifunctional oven 60x60 cm, 63 litres capacity</li> <li>• Touch controls and memory menu</li> <li>• Display with intuitive electronic programming</li> <li>• Automatic cooking with programmed recipes</li> <li>• Fast-preheating function</li> <li>• Cooling system with tangential ventilation</li> <li>• 1 fully extractable telescopic guides</li> <li>• 3 ply tempered glass door</li> <li>• Full-Glass door</li> <li>• Removable inner glass</li> <li>• Easy-Clean enamelling</li> <li>• Rotary roast</li> <li>• Safety shut-off system</li> <li>• Aluminium door handle</li> <li>• 5 shelf position</li> <li>• Energy class: A</li> <li>• Power supply: 220-240 V 50-60 Hz</li> </ul>		

	finish	code	cooking method
	glass	219	13
	<ul style="list-style-type: none"> <li>• Multifunctional oven 60x60 cm, 63 litres capacity</li> <li>• Touch controls and memory menu</li> <li>• Display with intuitive electronic programming</li> <li>• Automatic cooking with programmed recipes</li> <li>• Fast-preheating function</li> <li>• Cooling system with tangential ventilation</li> <li>• 1 fully extractable telescopic guides</li> <li>• 3 ply tempered glass door</li> <li>• Full-Glass door</li> <li>• Removable inner glass</li> <li>• Easy-Clean enamelling</li> <li>• Rotary roast</li> <li>• Safety shut-off system</li> <li>• Aluminium door handle</li> <li>• 5 shelf position</li> <li>• Energy class: A</li> <li>• Power supply: 220-240 V 50-60 Hz</li> </ul>		













	finish	code	cooking method
	glass	213	13
	<ul style="list-style-type: none"> <li>• Multifunctional oven 60x60 cm, 63 litres capacity</li> <li>• Touch controls and memory menu</li> <li>• Display with intuitive electronic programming</li> <li>• Automatic cooking with programmed recipes</li> <li>• Fast-preheating function</li> <li>• Cooling system with tangential ventilation</li> <li>• 1 fully extractable telescopic guides</li> <li>• 3 ply tempered glass door</li> <li>• Full-Glass door</li> <li>• Removable inner glass</li> <li>• Easy-Clean enamelling</li> <li>• Rotary roast</li> <li>• Safety shut-off system</li> <li>• Aluminium door handle</li> <li>• 5 shelf position</li> <li>• Energy class: A</li> <li>• Power supply: 220-240 V 50-60 Hz</li> </ul>		

	finish	code	cooking method
	glass	220	13
	<ul style="list-style-type: none"> <li>• Multifunctional oven 60x60 cm, 63 litres capacity</li> <li>• Touch controls and memory menu</li> <li>• Display with intuitive electronic programming</li> <li>• Automatic cooking with programmed recipes</li> <li>• Fast-preheating function</li> <li>• Cooling system with tangential ventilation</li> <li>• 1 fully extractable telescopic guides</li> <li>• 3 ply tempered glass door</li> <li>• Full-Glass door</li> <li>• Removable inner glass</li> <li>• Easy-Clean enamelling</li> <li>• Rotary roast</li> <li>• Safety shut-off system</li> <li>• Aluminium door handle</li> <li>• 5 shelf position</li> <li>• Energy class: A</li> <li>• Power supply: 220-240 V 50-60 Hz</li> </ul>		













	finish	code	cooking method
	glass	214	4
<ul style="list-style-type: none"> <li>• Multifunctional oven 60x60 cm, 63 litres capacity</li> <li>• Manually cooking with programmed recipes</li> <li>• Cooling system with tangential ventilation</li> <li>• 3 ply tempered glass door</li> <li>• Full-Glass door</li> <li>• Removable inner glass</li> <li>• Easy-Clean enamelling</li> <li>• Rotary roast</li> <li>• Safety shut-off system</li> <li>• Aluminium door handle</li> <li>• 5 shelf position</li> <li>• Energy class: A</li> <li>• Power supply: 220-240 V 50-60 Hz</li> </ul>			

















	finish	code	cooking method
	glass	217	13
<ul style="list-style-type: none"> <li>• Multifunctional oven 60x60 cm, 63 litres capacity</li> <li>• Touch controls</li> <li>• Display with intuitive electronic programming</li> <li>• Automatic cooking with programmed recipes</li> <li>• Cooling system with tangential ventilation</li> <li>• 1 fully extractable telescopic guides</li> <li>• 3 ply tempered glass door</li> <li>• Full-Glass door</li> <li>• Removable inner glass</li> <li>• Easy-Clean enamelling</li> <li>• Rotary roast</li> <li>• Safety shut-off system</li> <li>• Aluminium door handle</li> <li>• 5 shelf position</li> <li>• Energy class: A</li> <li>• Power supply: 220-240 V 50-60 Hz</li> </ul>			





















	finish	code	cooking method
	glass	215	10
<ul style="list-style-type: none"> <li>• Multifunctional oven 60x60 cm, 63 litres capacity</li> <li>• Touch controls and memory menu</li> <li>• Display with intuitive electronic programming</li> <li>• Automatic cooking with programmed recipes</li> <li>• Fast-preheating function</li> <li>• Cooling system with tangential ventilation</li> <li>• 1 fully extractable telescopic guides</li> <li>• 3 ply tempered glass door</li> <li>• Full-Glass door</li> <li>• Removable inner glass</li> <li>• Easy-Clean enamelling</li> <li>• Rotary roast</li> <li>• Safety shut-off system</li> <li>• Aluminium door handle</li> <li>• 5 shelf position</li> <li>• Energy class: A</li> <li>• Power supply: 220-240 V 50-60 Hz</li> </ul>			



















	finish	code	cooking method
	glass	230	13
<ul style="list-style-type: none"> <li>• Multifunctional oven 60x60 cm, 63 litres capacity</li> <li>• Touch controls</li> <li>• Display with intuitive electronic programming</li> <li>• Automatic cooking with programmed recipes</li> <li>• Cooling system with tangential ventilation</li> <li>• 1 fully extractable telescopic guides</li> <li>• 3 ply tempered glass door</li> <li>• Full-Glass door</li> <li>• Removable inner glass</li> <li>• Easy-Clean enamelling</li> <li>• Rotary roast</li> <li>• Safety shut-off system</li> <li>• Aluminium door handle</li> <li>• 5 shelf position</li> <li>• Energy class: A</li> <li>• Power supply: 220-240 V 50-60 Hz</li> </ul>			







	finish	code	cooking method
	glass	233	13
	<ul style="list-style-type: none"> <li>• Multifunctional oven 60x60 cm, 63 litres capacity</li> <li>• Touch controls</li> <li>• Display with intuitive electronic programming</li> <li>• Automatic cooking with programmed recipes</li> <li>• Cooling system with tangential ventilation</li> <li>• 1 fully extractable telescopic guides</li> <li>• 3 ply tempered glass door</li> <li>• Full-Glass door</li> <li>• Removable inner glass</li> <li>• Easy-Clean enamelling</li> <li>• Rotary roast</li> <li>• Safety shut-off system</li> <li>• Aluminium door handle</li> <li>• 5 shelf position</li> <li>• Energy class: A</li> <li>• Power supply: 220-240 V 50-60 Hz</li> </ul>		











63L





13P



EASY Clean







	finish	code	cooking method
	glass	222	9
	<ul style="list-style-type: none"> <li>• Multifunctional oven 60x60 cm, 63 litres capacity</li> <li>• Touch controls</li> <li>• Display with intuitive electronic programming</li> <li>• Automatic cooking with programmed recipes</li> <li>• Cooling system with tangential ventilation</li> <li>• 1 fully extractable telescopic guides</li> <li>• 3 ply tempered glass door</li> <li>• Full-Glass door</li> <li>• Removable inner glass</li> <li>• Easy-Clean enamelling</li> <li>• Rotary roast</li> <li>• Safety shut-off system</li> <li>• Aluminium door handle</li> <li>• 5 shelf position</li> <li>• Energy class: A</li> <li>• Power supply: 220-240 V 50-60 Hz</li> </ul>		









63L





9P



EASY Clean





	finish	code	cooking method
	glass	221	9
	<ul style="list-style-type: none"> <li>• Multifunctional oven 60x60 cm, 63 litres capacity</li> <li>• Touch controls</li> <li>• Display with intuitive electronic programming</li> <li>• Automatic cooking with programmed recipes</li> <li>• Cooling system with tangential ventilation</li> <li>• 1 fully extractable telescopic guides</li> <li>• 3 ply tempered glass door</li> <li>• Full-Glass door</li> <li>• Removable inner glass</li> <li>• Easy-Clean enamelling</li> <li>• Rotary roast</li> <li>• Safety shut-off system</li> <li>• Aluminium door handle</li> <li>• 5 shelf position</li> <li>• Energy class: A</li> <li>• Power supply: 220-240 V 50-60 Hz</li> </ul>		









63L





9P



EASY Clean





	finish	code	cooking method
	glass	223	8
	<ul style="list-style-type: none"> <li>• Multifunctional oven 60x60 cm, 63 litres capacity</li> <li>• Touch controls</li> <li>• Display with intuitive electronic programming</li> <li>• Automatic cooking with programmed recipes</li> <li>• Cooling system with tangential ventilation</li> <li>• 1 fully extractable telescopic guides</li> <li>• 3 ply tempered glass door</li> <li>• Full-Glass door</li> <li>• Removable inner glass</li> <li>• Easy-Clean enamelling</li> <li>• Rotary roast</li> <li>• Safety shut-off system</li> <li>• Aluminium door handle</li> <li>• 5 shelf position</li> <li>• Energy class: A</li> <li>• Power supply: 220-240 V 50-60 Hz</li> </ul>		









63L



8P





EASY Clean





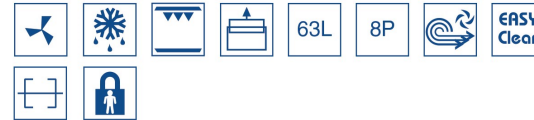



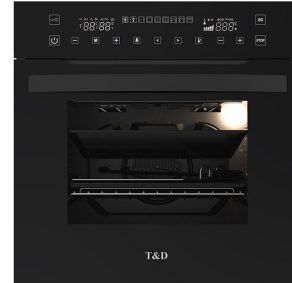

	finish	code	cooking method
	glass	224	4
<ul style="list-style-type: none"> <li>• Multifunctional oven 60x60 cm, 63 litres capacity</li> <li>• Manually cooking with programmed recipes</li> <li>• Cooling system with tangential ventilation</li> <li>• 3 ply tempered glass door</li> <li>• Full-Glass door</li> <li>• Removable inner glass</li> <li>• Easy-Clean enamelling</li> <li>• Rotary roast</li> <li>• Safety shut-off system</li> <li>• Aluminium door handle</li> <li>• 5 shelf position</li> <li>• Energy class: A</li> <li>• Power supply: 220-240 V 50-60 Hz</li> </ul>			
			





	finish	code	cooking method
	glass	226	8
<ul style="list-style-type: none"> <li>• Multifunctional oven 60x60 cm, 63 litres capacity</li> <li>• Touch controls</li> <li>• Display with intuitive electronic programming</li> <li>• Automatic cooking with programmed recipes</li> <li>• Cooling system with tangential ventilation</li> <li>• 3 ply tempered glass door</li> <li>• Full-Glass door</li> <li>• Removable inner glass</li> <li>• Easy-Clean enamelling</li> <li>• Rotary roast</li> <li>• Safety shut-off system</li> <li>• Aluminium door handle</li> <li>• 5 shelf position</li> <li>• Energy class: A</li> <li>• Power supply: 220-240 V 50-60 Hz</li> </ul>			
			

	finish	code	cooking method
	glass	225	4
<ul style="list-style-type: none"> <li>• Multifunctional oven 60x60 cm, 63 litres capacity</li> <li>• Manually cooking with programmed recipes</li> <li>• Cooling system with tangential ventilation</li> <li>• 3 ply tempered glass door</li> <li>• Full-Glass door</li> <li>• Removable inner glass</li> <li>• Easy-Clean enamelling</li> <li>• Rotary roast</li> <li>• Safety shut-off system</li> <li>• Aluminium door handle</li> <li>• 5 shelf position</li> <li>• Energy class: A</li> <li>• Power supply: 220-240 V 50-60 Hz</li> </ul>			
			

	finish	code	cooking method
	glass	228	8
<ul style="list-style-type: none"> <li>• Multifunctional oven 60x60 cm, 63 litres capacity</li> <li>• Touch controls</li> <li>• Display with intuitive electronic programming</li> <li>• Automatic cooking with programmed recipes</li> <li>• Fast-preheating function</li> <li>• Cooling system with tangential ventilation</li> <li>• 1 fully extractable telescopic guides</li> <li>• 3 ply tempered glass door</li> <li>• Full-Glass door</li> <li>• Removable inner glass</li> <li>• Easy-Clean enamelling</li> <li>• Rotary roast</li> <li>• Safety shut-off system</li> <li>• Aluminium door handle</li> <li>• 5 shelf position</li> <li>• Energy class: A</li> <li>• Power supply: 220-240 V 50-60 Hz</li> </ul>			
			



	finish	code	cooking method
	glass	229	13





- Multifunctional oven 60x60 cm, 78 litres capacity
- Touch controls
- Display with intuitive electronic programming
- Automatic cooking with programmed recipes
- Fast-preheating function
- Cooling system with tangential ventilation
- 2 fully extractable telescopic guides
- 4 ply tempered glass door
- Full-Glass door
- Removable inner glass
- Easy-Clean enamelling
- Rotary roast
- Safety shut-off system
- Aluminium door handle
- 5 shelf position
- Energy class: A
- Power supply: 220-240 V 50-60 Hz







78L





13P



	finish	code	cooking method
	glass	232	13





- Multifunctional oven 60x60 cm, 63 litres capacity
- Touch controls
- Display with intuitive electronic programming
- Automatic cooking with programmed recipes
- Cooling system with tangential ventilation
- 1 fully extractable telescopic guides
- 3 ply tempered glass door
- Full-Glass door
- Removable inner glass
- Easy-Clean enamelling
- Rotary roast
- Safety shut-off system
- Aluminium door handle
- 5 shelf position
- Energy class: A
- Power supply: 220-240 V 50-60 Hz

63L

13P



## Sinks

T&D takes great care to use materials able to provide the best performance. Our entire range is made with AISI 304 - 18/10 and AISI 316 austenitic steels. Thanks to the high percentages of chrome and nickel they contain, they give a particularly bright finish, and make the products extremely sturdy and absolutely resistant to rust and corrosion.

## Built-in and beyond

The methods with which worktops can be built-in have become increasingly more varied and customized. T&D was the first sink manufacturer to have researched and used the new recessing methods and has thus acquired a great deal of experience. It now offers the most comprehensive range available on the market, with flush-mount, flat-edge and under-mount installation.



### Diamond-shaped bottom

water drainage on the bowl's bottom is an important feature, always well cared for on T&D sinks. In the squared-out, flatbottomed sinks, the draining is ensured by the elegant diamond-shaped creases that make the water flow easier.



### Spacious bowls

The bowls in many of the versions are more than 20 cm deep, thus sizeable and practical for all washing operations.



### Sturdy sinks

As a result, also owing to our long experience, we are able to construct "sturdy" sinks displaying a unique design. This icon marks the models with steel thickness of 1 mm.



### Glass doors

Tempered black glass door





## Acciaio Series

finish	code	depth
Steel	350	20 cm



AISI 304 stainless steel  
dimensions: 1160x500 mm  
cut-out: 1100x440 mm  
Stainless steel drain  
Tow bowls



finish	code	depth
steel	351	20 cm



AISI 304 stainless steel  
dimensions: 1160x500 mm  
cut-out: 1100x440 mm  
Stainless steel drain  
Tow bowls



finish	code	depth
steel/glass	352	20 cm



AISI 304 stainless steel  
dimensions: 790x530 mm  
cut-out: 730x470 mm  
Tempered glass  
Stainless steel drain  
Tow bowls



finish	code	depth
steel	353	20 cm



AISI 304 stainless steel  
dimensions: 890x450 mm  
cut-out: 870x430 mm  
Stainless steel drain  
Tow bowls



finish	code	depth
steel	354	20 cm



AISI 304 stainless steel  
dimensions: **780x450 mm**  
cut-out: 760x430 mm  
Stainless steel drain  
Tow bowls



finish	code	depth
steel	357	20 cm



AISI 304 stainless steel  
dimensions: **780x450 mm**  
cut-out: 760x430 mm  
Stainless steel drain  
Tow bowls



finish	code	depth
steel	355	20 cm



AISI 304 stainless steel  
dimensions: **750x450 mm**  
cut-out: 730x430 mm  
Stainless steel drain  
Single bowl



finish	code	depth
steel	358	20 cm



AISI 304 stainless steel  
dimensions: **450x450 mm**  
cut-out: 430x430 mm  
Stainless steel drain  
Single bowl



finish	code	depth
Steel	356	20 cm



AISI 304 stainless steel  
dimensions: **890x450 mm**  
cut-out: 870x430 mm  
Stainless steel drain  
Tow bowls



finish	code	depth
steel	359	20 cm



AISI 304 stainless steel  
dimensions: **390x450 mm**  
cut-out: 370x430 mm  
Stainless steel drain  
Single bowl





Tap rotation



Strengthening



Double water

## Leonessa Series

	finish	code	-
	steel	503	-
AISI 304 stainless steel			



	finish	code	-
	steel	501	-
AISI 304 stainless steel			



	finish	code	-
	steel	504	-
AISI 304 stainless steel			



	finish	code	-
	Steel	502	-
AISI 304 stainless steel			



	finish	code	-
	steel	505	-
AISI 304 stainless steel			

